

STARGEL 12

UPPER VIEW WATER VERSION

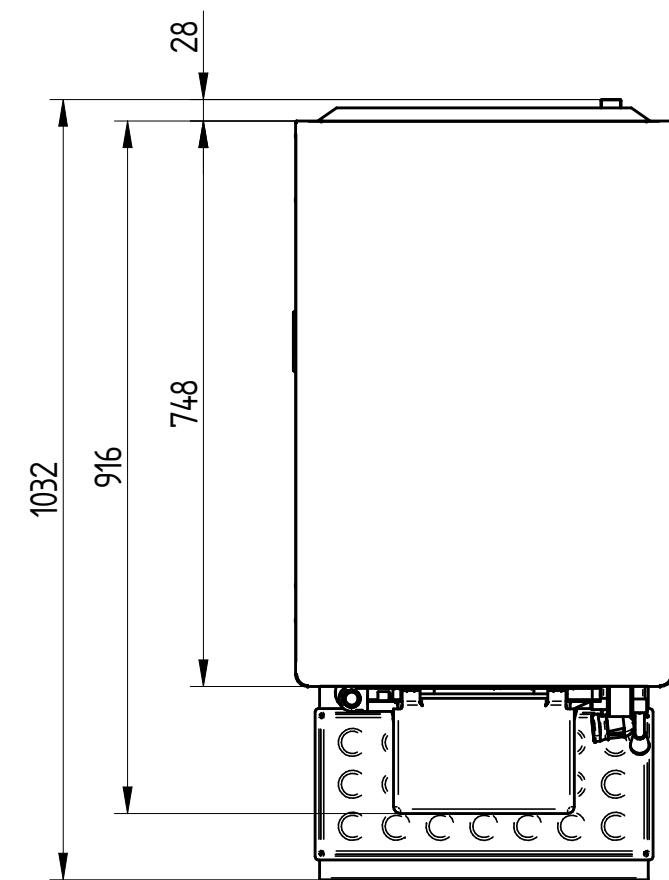

UPPER VIEW AIR VERSION

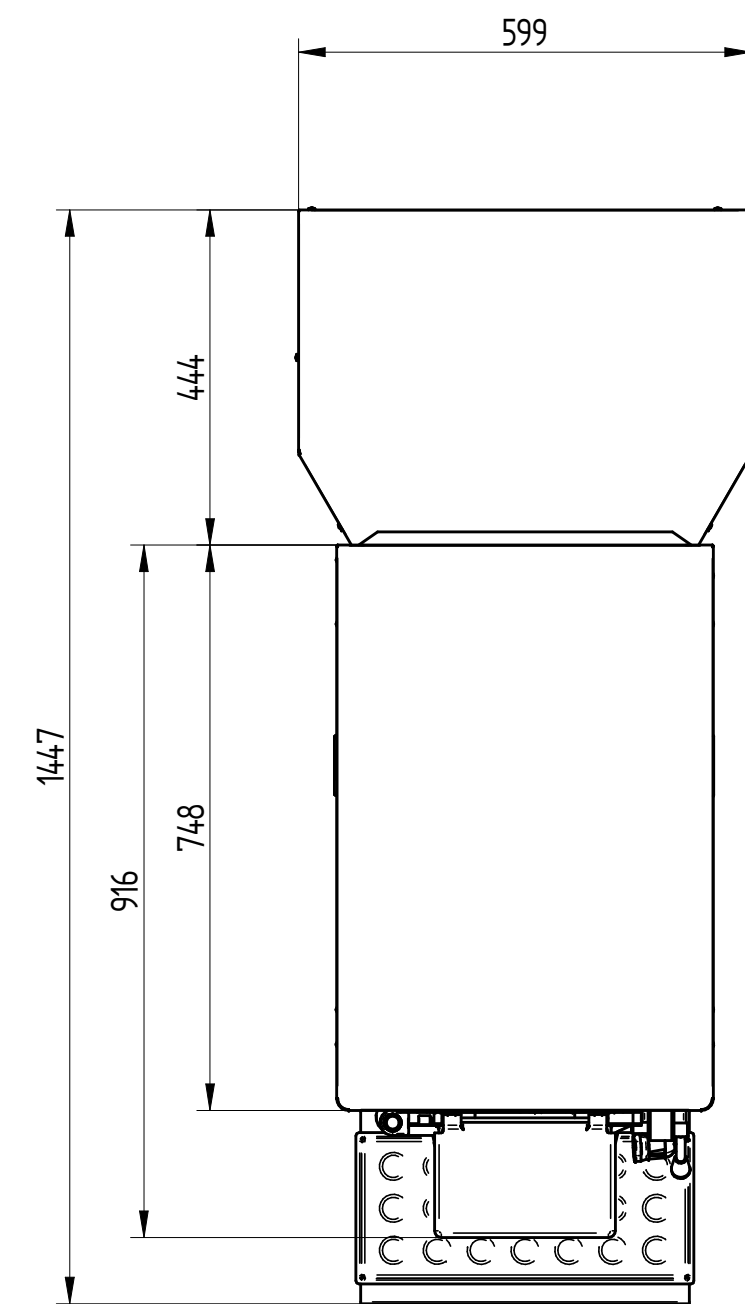

REAR VIEW WATER VERSION

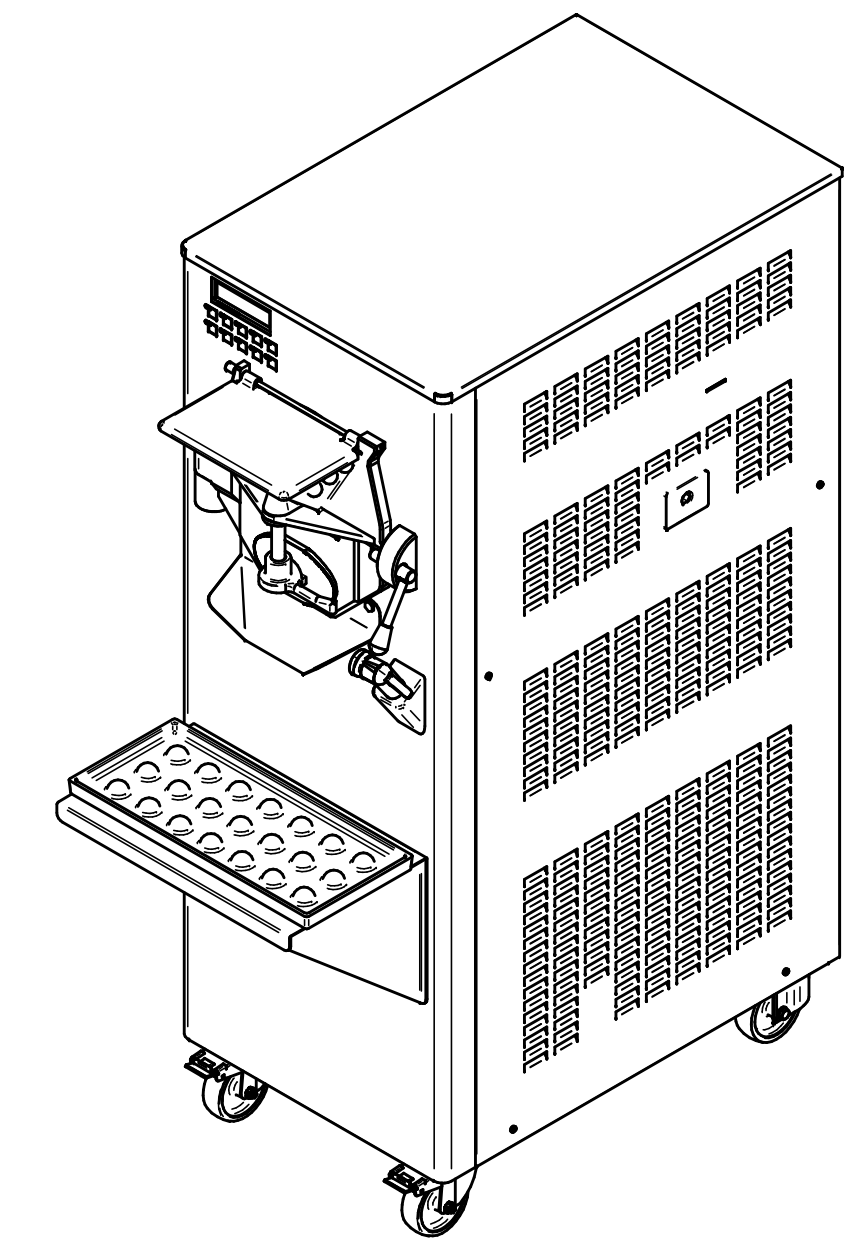
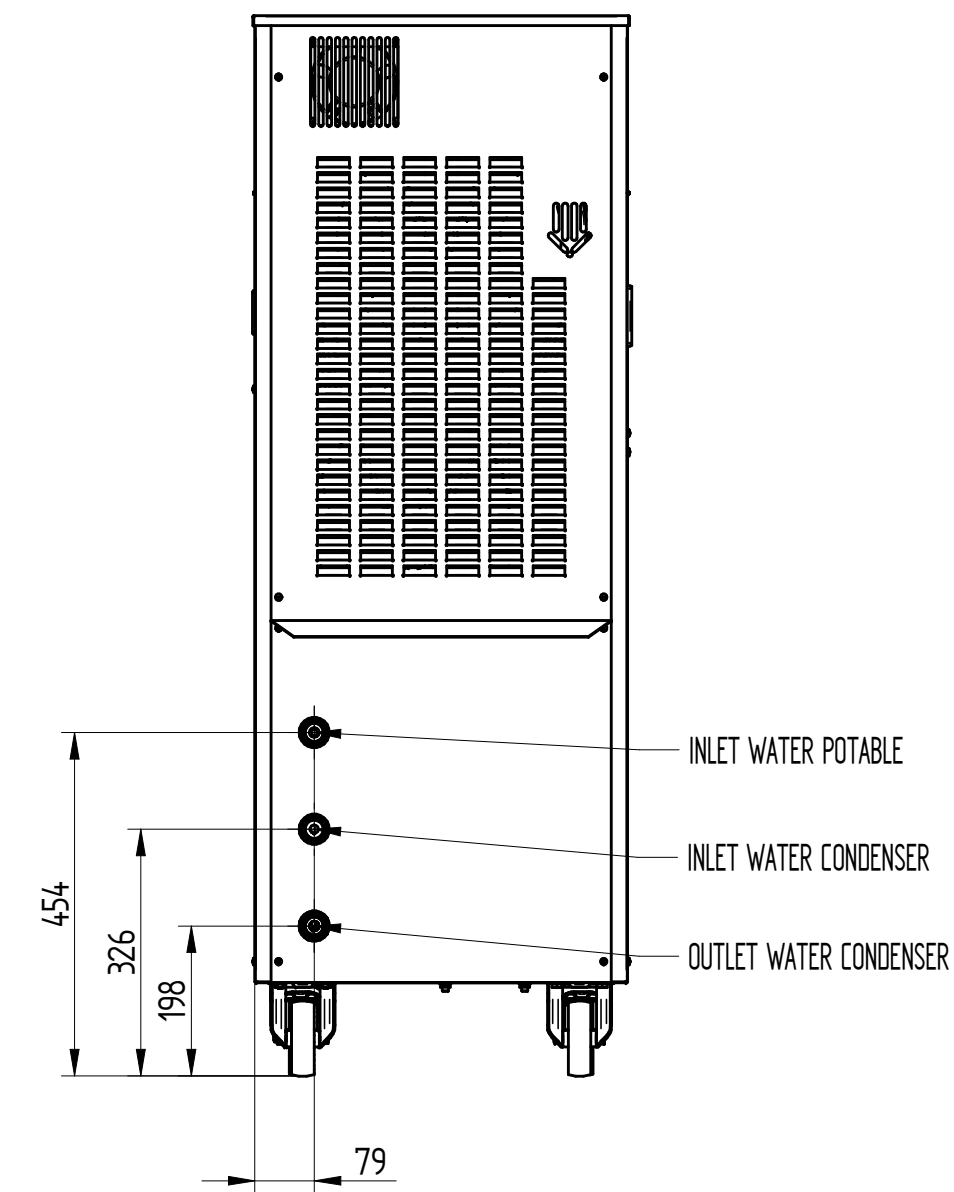

FRONT VIEW

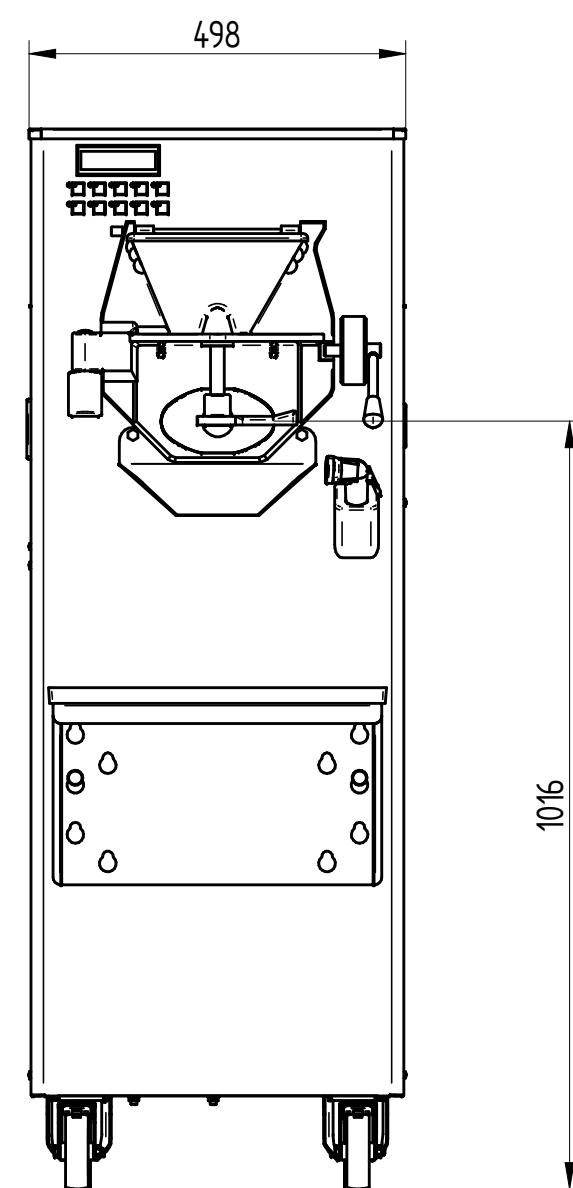

LEFT SIDE VIEW WATER VERSION

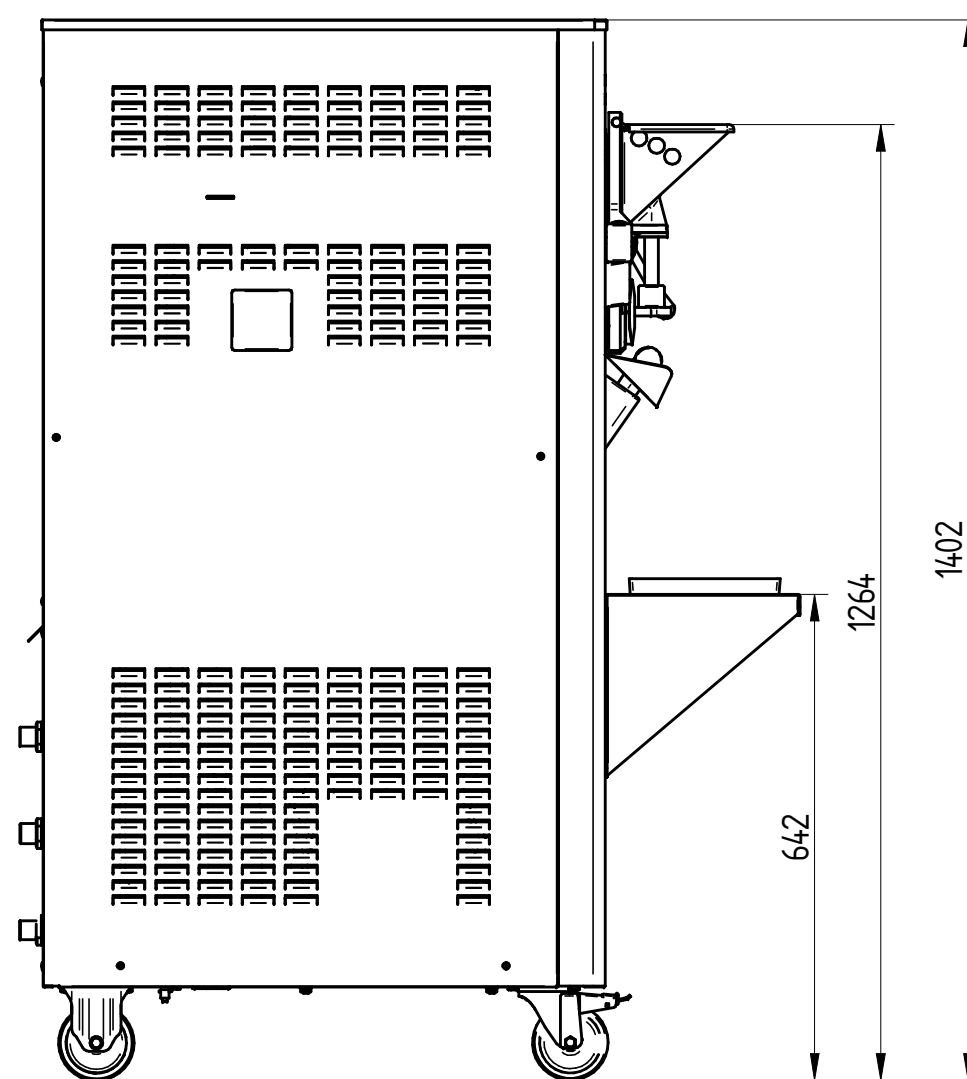

LEFT SIDE VIEW AIR VERSION

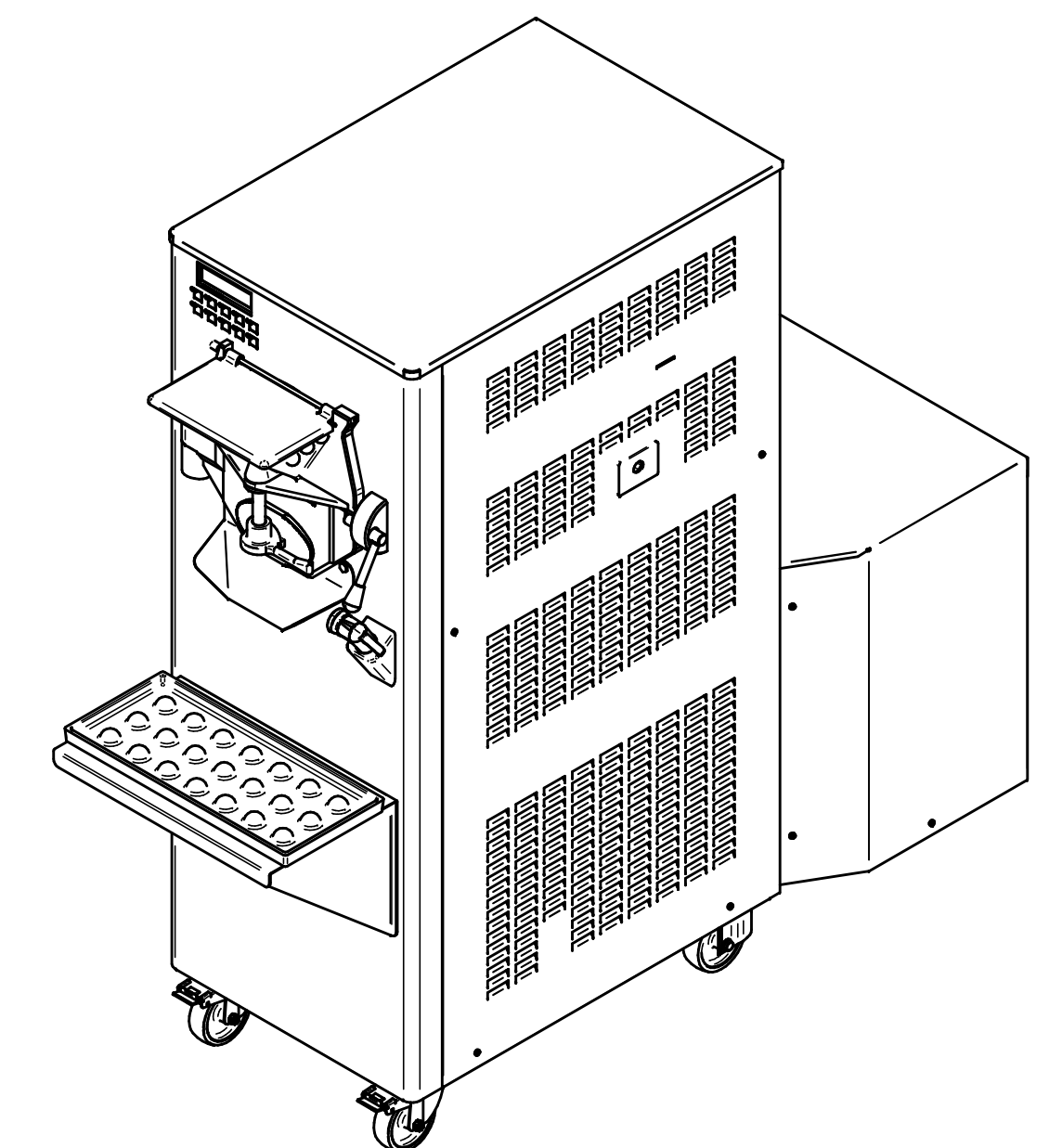
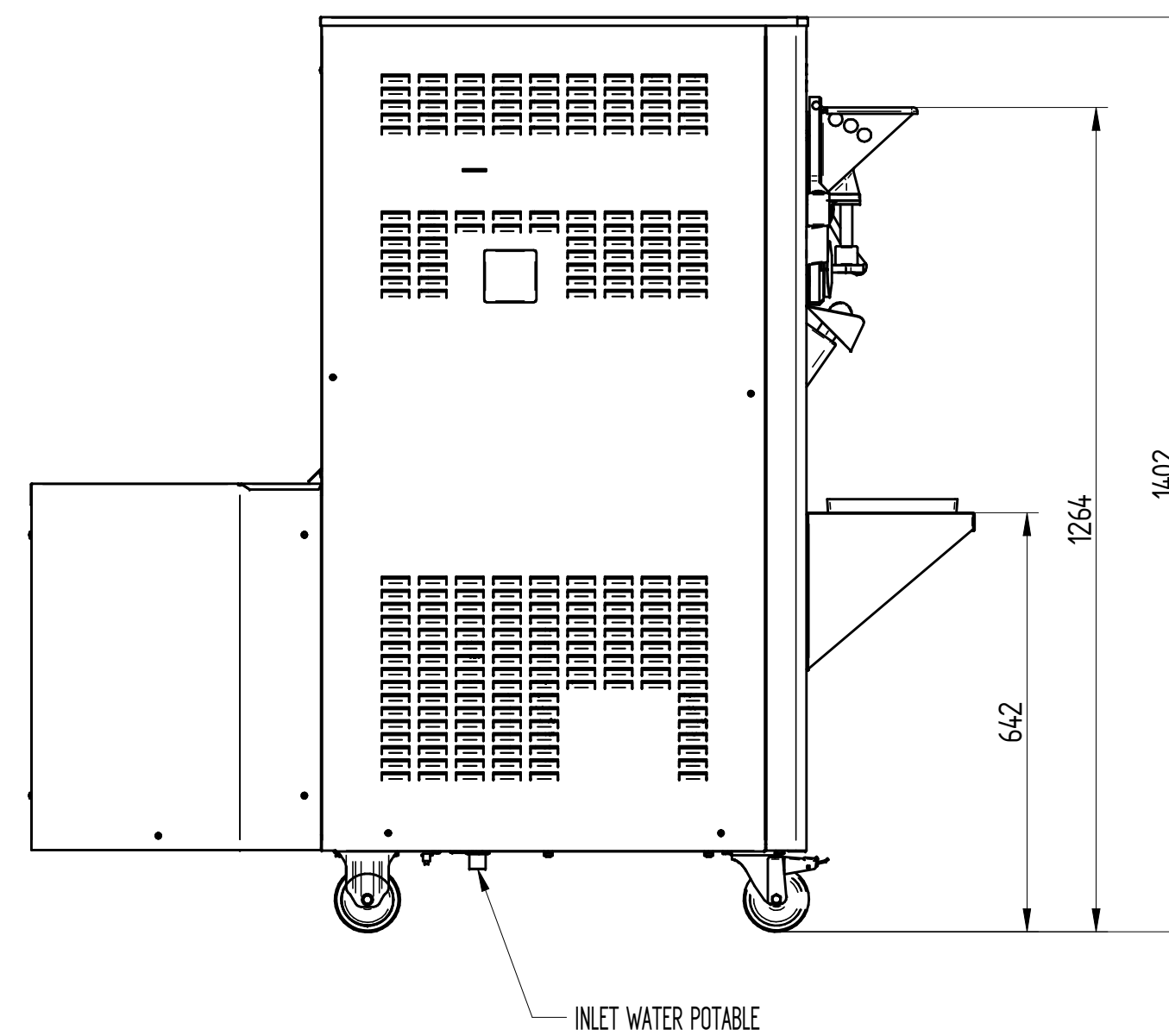

DATE	REV.
07/03/2017	00